



window styling

5
year

Luxaflex®
Guarantee

Guarantee, Installation and Operating Instructions

Luxaflex® Roller Blinds



Guarantee, Installation and Operating Instructions Luxaflex® Roller Blinds

Dear Customer,

We thank you for choosing Luxaflex® products. In the unlikely event that the Luxaflex product guarantee service is needed, please contact the dealer from whom the product was purchased. Alternatively you may contact a member of our authorised Luxaflex® service network. In order to minimise any unnecessary inconvenience, we suggest that the product installation instructions are read carefully before contacting the dealer on our service network.

GUARANTEE

Luxaflex® guarantees that all Luxaflex® window covering products are free from material and assembly defects, provided that such products were properly installed in a domestic situation. For non-domestic installations, refer to the Luxaflex® general sales conditions. The obligation of Luxaflex® is limited to repair or replacement of the defective materials or components. Repairs will be made with like or similar parts. The guarantee is limited to the original purchaser.

Scope of warranty	Year since date of purchase				
	1 yr	2 yrs	3 yrs	4 yrs	5 yrs
Removal of product from end user's window	X	X	X	X	X
Carriage (to - from factory)	✓	X	X	X	X
Labour (assembly / repair)	✓	X	X	X	X
Re-installation of product at end users window	X	X	X	X	X
Components (with like or similar parts)	✓	✓	✓	✓	✓
Cords	✓	✓	✓	X	X
Fabric (with like or similar fabric)	✓	✓	✓	X	X
Consequential loss	X	X	X	X	X

This guarantee is invalid if the damage or failure is caused by:

- Accident • Misuse/Abuse • Alteration • Motorised devices • Exposure to elements
- Normal wear and tear • Blinds that are not fitted in a domestic situation.
- Failure to follow measurement, installation, cleaning and maintenance instructions

The guarantee is exclusive and in lieu of all other obligations, liabilities or warranties. In no event shall Luxaflex be liable or responsible for incidental or consequential damages or for any other direct or indirect damage, loss, cost, expense or fee.

The guarantee does not affect the consumers statutory rights under applicable national laws in force, nor the consumers rights against the dealer arising from their sales/purchase contract.

The Luxaflex® Roller Blind Collection comes with the following components:

- 1 set of steel mounting brackets with plastic covers (type 10, standard).
- Mounting profile with clips or brackets (type 20/25).
- Mounting profile with decorative cassette (type 30/35), either with clips for wall mounting or brackets for ceiling mounting.
- 1 set of mounting screws (all types).

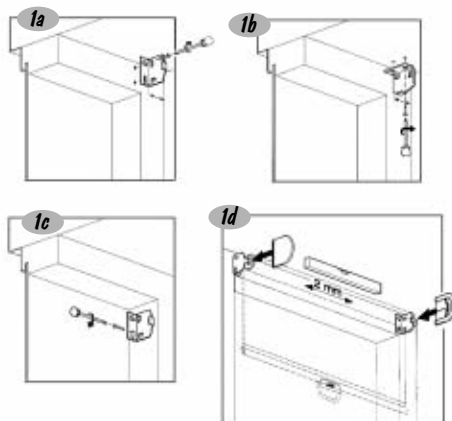
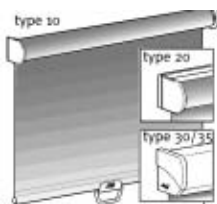

STANDARD INSTALLATION

Make sure that the position of the brackets is such that the Luxaflex® roller blind will not come into contact with protruding parts, such as window or door handles, window sills etc.

1a. Installation of standard brackets (Type 10)

The brackets can be used for: wall mounting (1a), ceiling mounting (also suitable for inclined ceilings) (1b) or fixing to the side, in the recess of the window (1c). The same bracket is used at both ends of the roller.

1b. Positioning of the brackets

Mark the position of the holes for the first bracket, drill the holes and fix the bracket in place. It is recommended to insert the bracket cover over the bracket before marking the position of the bracket. Then place the other bracket on the other end of the blind and mark its position. (The blind should have 2mm of play between the brackets and roller.) Make sure that the second bracket is marked so that it is level with the first, drill the holes and fix the bracket in place.

Installing the roller blind

B: It is easier to install the blind into the brackets while the plastic bracket covers are removed.

2. Chain/Endless cord

- 2a. Insert the control side of the blind in the bracket. The control side has a star-shaped hole, which makes it possible to mount the blind in different angles. Make sure that the chain/endless cord hangs straight downward.
- 2b. Bring the bearing end of the blind to the lip of the bracket. Align the slot on the bearing with edge of the bracket. Gently push the bearing into the bracket until a 'click' is heard. This can be done either from the top or under side.
- 2c. Insert the plastic covers over the mounting brackets.

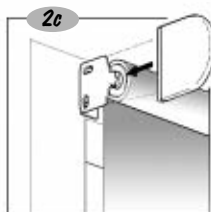
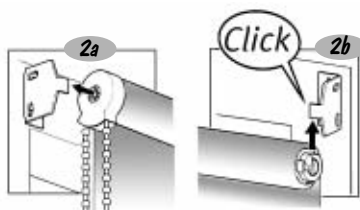

3. "Soft-raise" spring operation

- 3a. Insert the cross-shaped opening of the spring, on the LH side of the blind in the bracket. If you have ordered your blind to be "reverse rolled" (cloth rolling to room side), the cross shaped opening should be mounted to the RH bracket. (The positioning of the cross onto the brackets is not important).
- 3b. Bring the bearing end of the blind to the lip of the bracket. Align the slot on the bearing with edge of the bracket. Gently push the bearing into the bracket until a 'click' is heard. This can be done either from the top or under side.
- 3b. Insert the plastic covers over the mounting brackets.

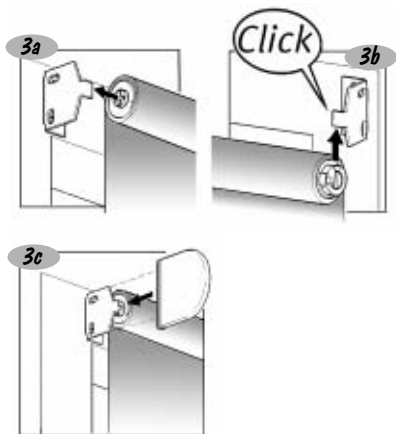

4. 'Non Softraise' spring operation

You will have been supplied with two brackets. A 'pin' end bracket (4a) and a 'spring' end bracket (4b).

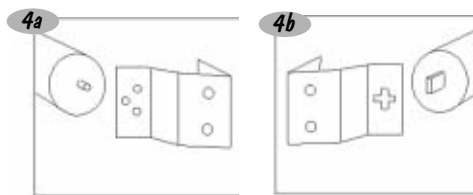

If your roller cloth is rolling upwards with the fabric nearest the window, the 'spring' end bracket should be mounted on the left. If your roller fabric is 'reverse rolled' the 'spring' end bracket should be mounted on the right. Note: the 'pin' end bracket has three holes for the pin, depending on whether the bracket is top or face fixed and fitted on the left or right. The 'pin' should always be fitted into the lower hole.

Mark the position of your brackets, allowing a little clearance between the roller and the brackets. Drill and plug as necessary and fix into position. Locate the pin end into it's bracket first. The spring end is located starting with the rectangular pin in a horizontal position. Slide the pin into the 'cross' hole from the rear if face fitting, the top if top fixing. The pin should be located so that it sits in the bottom of the cross. Your blind is now ready to be operated. If there is a problem with the tension of your roller, see the 'Spring Operation' section later in these instructions.

INSTALLATION OPTIONS

Installation with mounting clips

5. Fix the mounting clips against the wall or ceiling (always drill holes first, before fixing screws). Take account of the maximum distances between the clips, as indicated in the drawing.

5a. Mounting to ceiling (type 20 only)

The clip should be fixed on the ceiling so that the screw is (almost) centred in the slot and the lip points towards the rear.

5b. Mounting to the wall (type 20/30/35)

The clip should be fixed to the wall so that the screw is (almost) centred in the slot and the lip points downwards.

5c. Mounting to ceiling (type 30/35)

Mark off the position of the brackets on the ceiling, drill holes for the screws and fix the brackets in place.

Make sure that the brackets are fully parallel to each other.

Maintain the same maximum distances as for the mounting clips (see steps 4-5).

5d. Mounting to ceiling (type 25 only)

N.B. The mounting profile has a deeper internal groove at the bottom compared to the top!

Fit the brackets at the maximum spacing as shown in drawing 5. Turn the locking button so it is open (leg on button horizontal).

- 5e. Locate mounting profile onto the bottom of the bracket first then twist into bracket at top. When the profile is located into the bracket and centralised, the locking button can be turned to secure the profile into position.

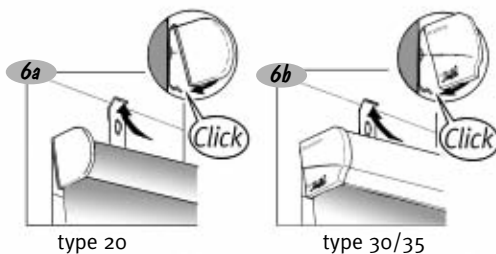
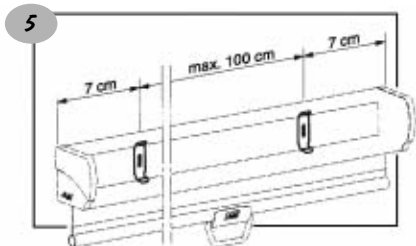

type 20

type 30/35

DEMOUNTING

Type 10

- 7a. Remove the plastic covers from the brackets.
7b. Push with your thumb against the lever on the bearing until the slot opens.

You can also use a screwdriver. You should then however take care to hold the blind in place, while pressing, in order to avoid dropping the blind after it's release from the brackets.



7a

7b

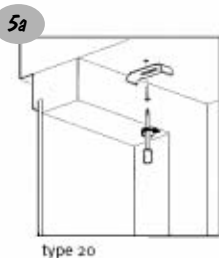

type 20

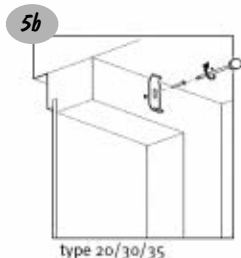

type 20/30/35

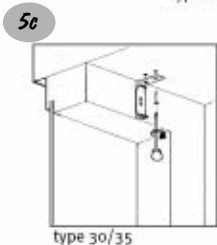

type 30/35



type 25

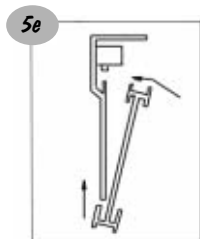

Type 20/30/35

8. Insert a screwdriver between profile and lip of the clip.
Gently turn the screwdriver until a click is heard.
NB: always work from the sides towards the middle, so that the roller blind continues to hang on the middle clip



SPRING OPERATION

When installing a Luxaflex® roller blind with tensioning spring, it is sometimes useful to adjust the tension of the spring. This is done as follows:
Always first install the roller blind, as described in point 3.

For type 30/35:

- 9a. Loosen the side covers and pull them towards you from the brackets pushing the underside of the cassette upwards may ease release of the end caps.
9b. The valance now hangs loose on the mounting profile and can be taken off.

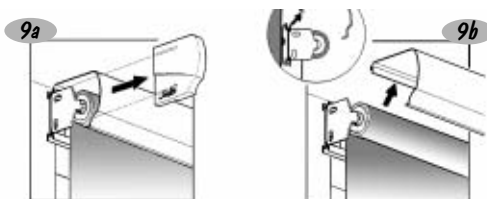

To increase the tension:

Pull the blind down and lock it into position. Demount the blind from the brackets and roll it up again by hand.

NB: every turn helps to increase the tension on the spring.

Re-insert the blind into the brackets and test the tension again by pulling the blind down and letting it roll up.

To decrease the tension:

Let the blind roll up completely, but make sure it is locked in position. Demount the blind from the brackets and roll the fabric off by hand. With every turn the tension on the spring will decrease. Re-install the roller blind into the brackets and test the tension by operating the blind.

For type 30/35:

Hang the cover profile on the mounting profile. Put the plastic covers back over the brackets and click them in place over the ends of the cover profile.

⚠ WARNING

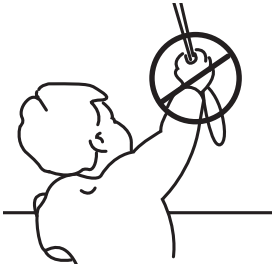

- Young children can STRANGLE in the loop of pull cords, chains and tapes and cords that operate window coverings. They can also wrap cords around their necks.
- To avoid strangulation and entanglement, keep cords out of the reach of young children.
- Move beds, cots and furniture away from window covering cords.
- Inner cords can pull down to form a loop, which can STRANGLE a young child.

CORD SAFETY DEVICE



Cord Cleat

- supplied with products having single pull cord

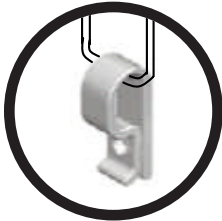

Endless cord/ Chain retainer

- supplied with products having endless chain or cord

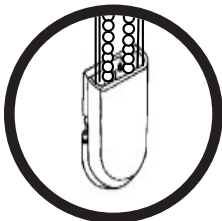

Double chain & cord retainer

- supplied with vertical louvre blinds having both endless cord and chain

Fitting

- First, ensure blind has been installed as per instructions.
- Select suitable position to fit appropriate retainer. If cord & cleat, making sure it is out of reach of children. If one of the cord/chain retainers, fit at position for length of chain/cord. Fit so that the retainer takes out slack but without over tightening.
- Mark and fix the retainer using the fixing provided. Check that a secure fixing has been achieved.
- In the case of single pull cord products, make sure cords are tied out of reach each time used.

Persons in charge of children are ultimately responsible for following the safety instructions provided by the manufacturer.



window styling

HunterDouglas Ltd. Window Fashion Division
Mersey Ind. Est., Heaton Mersey, Stockport, Cheshire SK4 3EQ.
Tel: 0161-442 9500 Fax: 0161-432 3200.